

# Duralíndia™

PROTECTING CORNERS

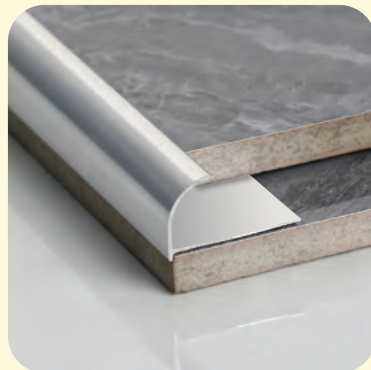
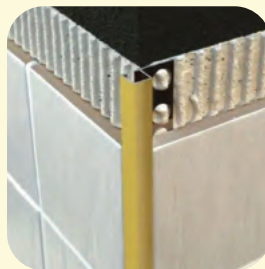

# PRODUCT CATALOGUE

[WWW.DURALINDIA.COM](http://WWW.DURALINDIA.COM)

# CONTENT

## Description

## Pages

Tile Trim (Tile Beading - PVC Glossy & Matte)

4

Tile Trim (Tile Beading - Marble Finish)

5

Tile Trim (Tile Beading - Closedtype )

6

Tile Trim Aluminium Round Nosing

7

Tile Trim Aluminium Square Edge

8

Tile Trim Round Nosing / Square Edge - Stainless Steel

9

Cove Trin - PVC

10

Cove Trim - Aluminium

11

Step Nosing (Stair case Nosing)

12

Step Nosing (for Existing Floor)

13

Step Nosing (for Existing Floor)

14

Corner Guard (Self Adhesive pvc) L- Type

15

Corner Guard L - Type

16

Corner Guard (Aluminium with PVC)

17

Corner Guard (Stainless Steel)

18

Tile Spacers

19

Tile Levelling System

20

Description	CONTENT	Pages
Parking Guard		21
Wall Guard		22
Skirting Profile		23
Skirting Toe Profile		24
Floor Divider		25
Coner Bead / Plaster Mesh		26
Expansion Joint (Floor to floor / Floor to wall)		27
Expansion Joint Cover		28
Control Joint		29
Tile Adhesive		30
Tile Grout		31
Speed Breaker / Car Stopper		32
Trans Profile		33
T - Section		34
Groove Profile		35
Backer Rod / Fiberglass Mesh		36
Tile Leveller machine / F - Profile		37
Wpc frame		38
Wpc Door		39



**Available Colour**  
*(There will be slight Variation in colour)*  
**Glossy**

New White (GLOSSY)	Off White (GLOSSY)	New Ivory (GLOSSY)
Black (GLOSSY)	Dark Grey (GLOSSY)	Grey (GLOSSY)
C.Brown (GLOSSY)	Brown (GLOSSY)	Red Brown or Burgundy (GLOSSY)
Alpine Blue ( Glossy )	Pink or Majenta (GLOSSY)	Terakotta (GLOSSY)
C.Beige (GLOSSY)		Beige ( GLOSSY )

**Available Colour**  
*(There will be slight Variation in colour)*  
**Matte**

New White (Matte)	Off White (Matte)	Ivory (Matte)
Pista Green (Matte)		Sky Blue (Matte)

**Available Sizes**

- H = 7 mm
- H = 9.5 mm
- H = 10.5 mm
- H = 11.5 mm

**Length**

- 7 feet
- 7 feet
- 7 feet
- 7 feet

**Available Quantity**

- 10 Nos / Pack and
- 200 Nos / Box

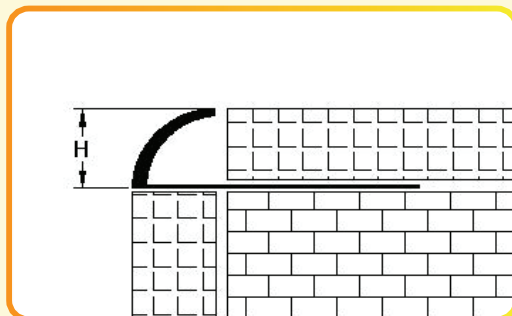

**DIMENSIONS**



**APPLICATION**



**USAGE**

## Tile Trim (Tile Beading Pvc - Marble Finish)



### Available Sizes

H = 7 mm

H = 10.5 mm

### Length

7 feet

7 feet

### Available Quantity

10 Nos / Pack and

200 Nos / Box

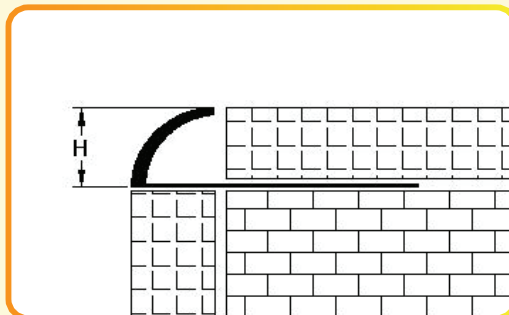

DIMENSIONS



APPLICATION



USAGE



*Tile Trim (Tile Beading Pvc - Closed type )*

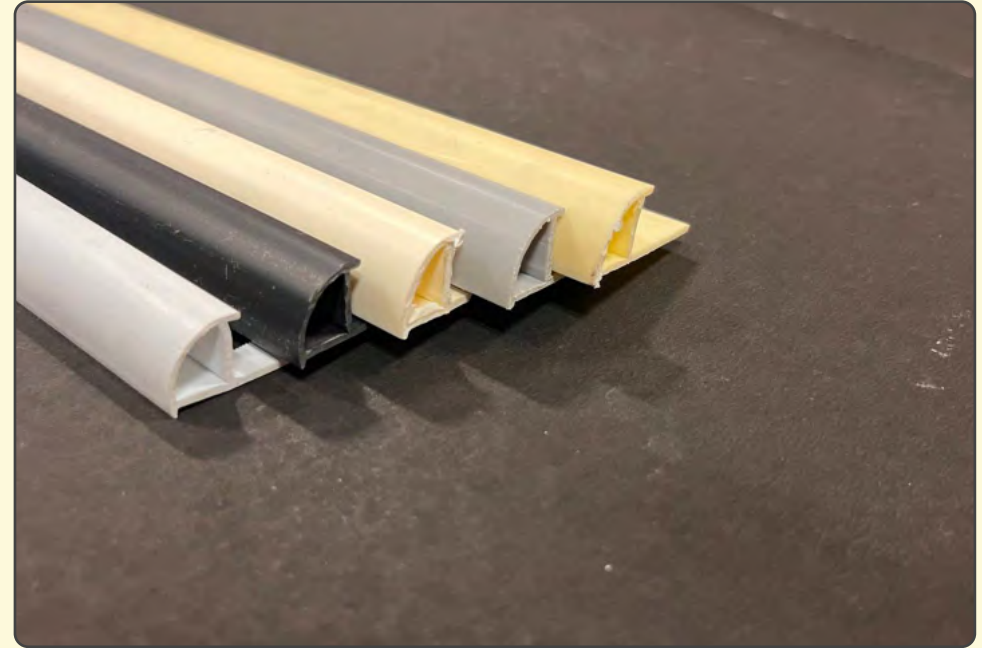

*Available Sizes*

H = 10.5 mm

*Length*

7 feet

*Available Quantity*

10 Nos / Pack and  
100 Nos / Box

*Colours:*

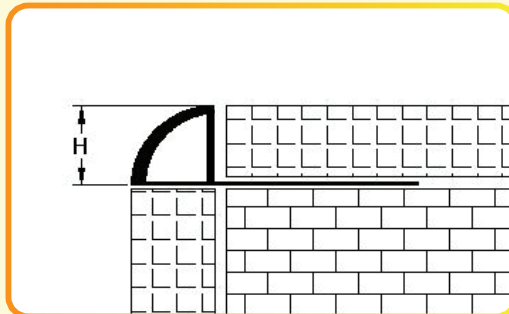

DIMENSIONS



APPLICATION



USAGE

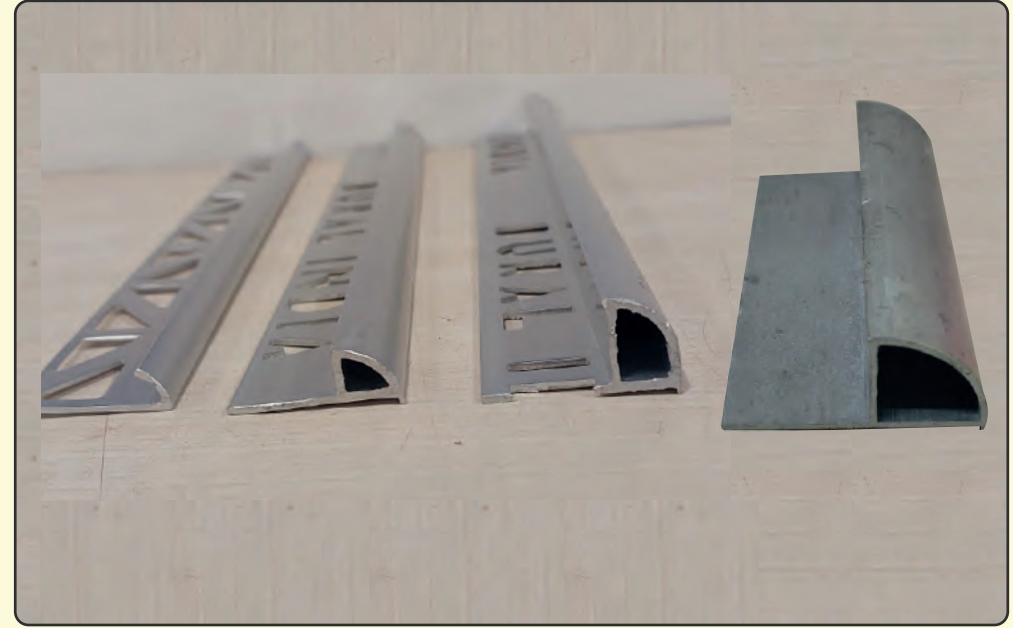
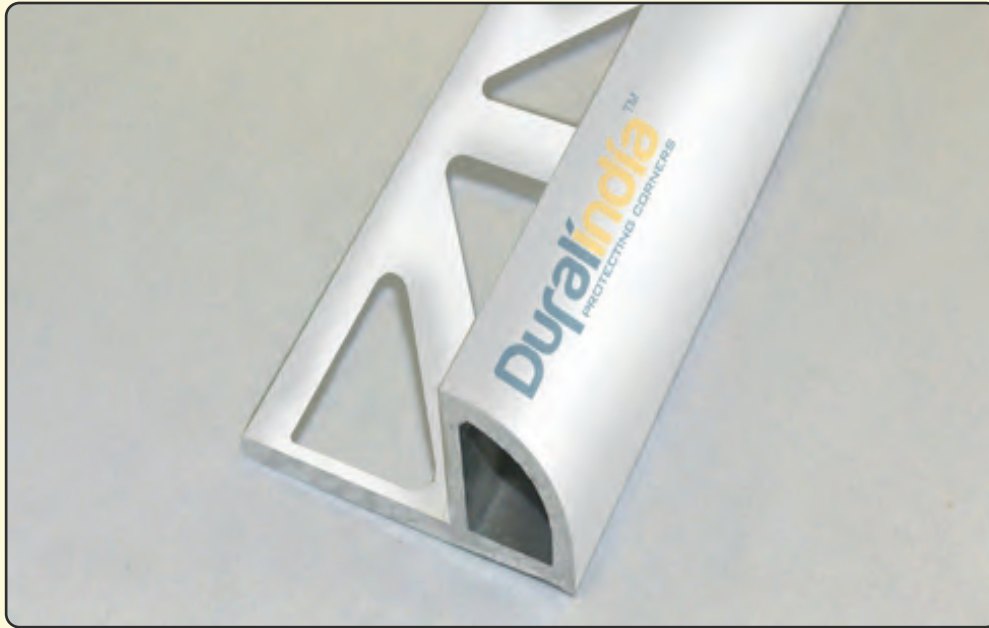

**Available Sizes**

- H = 7 mm
- H = 10 mm
- H = 14 mm
- H = 25 mm

**Length**

- 3 Mtr
- 3 Mtr
- 3 Mtr
- 3 Mtr

**Available Sizes**

- H = 7 mm (Natural /Anodised / powder coated)
- H = 10 mm (Natural /Anodised / powder coated)
- H = 14 mm (Natural /Anodised / powder coated)
- H = 25 mm (Natural /Anodised / powder coated)

**Length**

- 3 Mtr
- 3 Mtr
- 3 Mtr
- 3 Mtr

**Colours:**

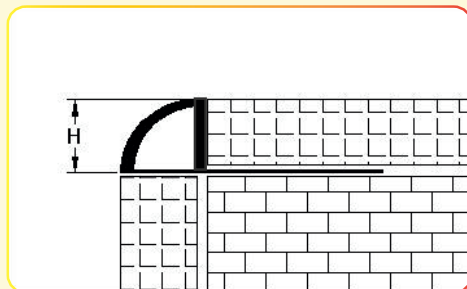

DIMENSIONS



APPLICATION



USAGE

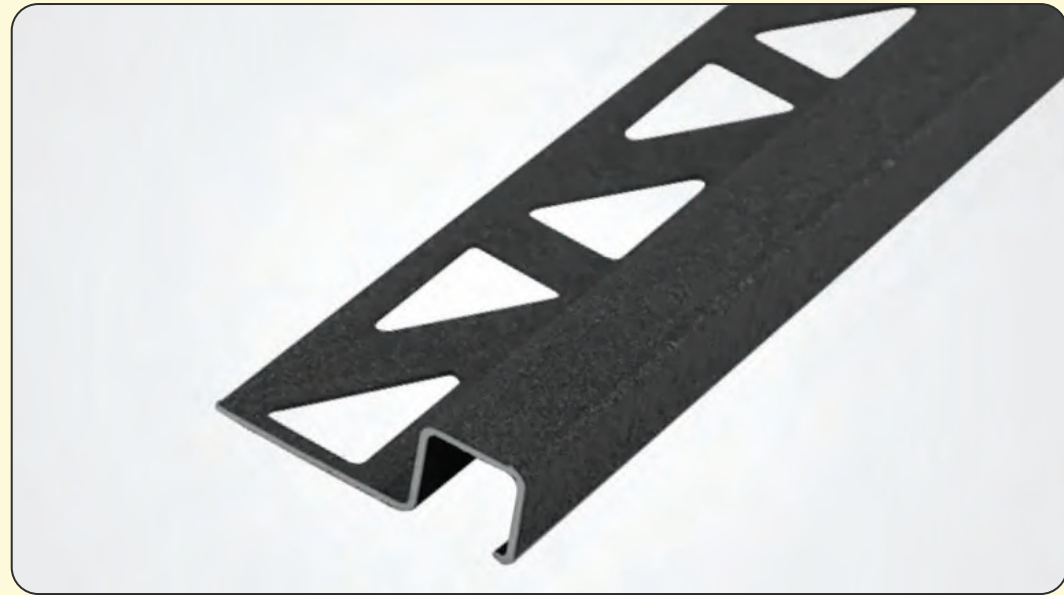

**Available Sizes**

H = 10 mm (Natural)

H = 10 mm (Anodised / powder coated)

**Length**

3 Mtr

3 Mtr

**Colours:**

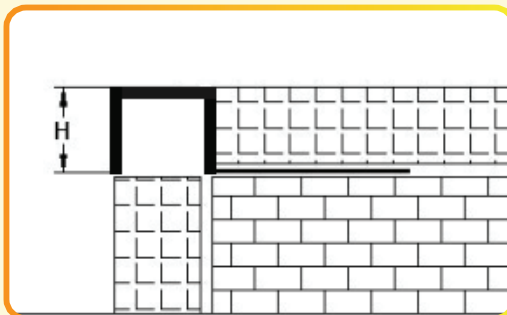

DIMENSIONS



APPLICATION



USAGE



**Tile Trim Round Nosing - Stainless Steel**



**Tile Trim Square Edge - Stainless Steel**



**Tile Trim Square Edge - Titanium Stainless Steel**

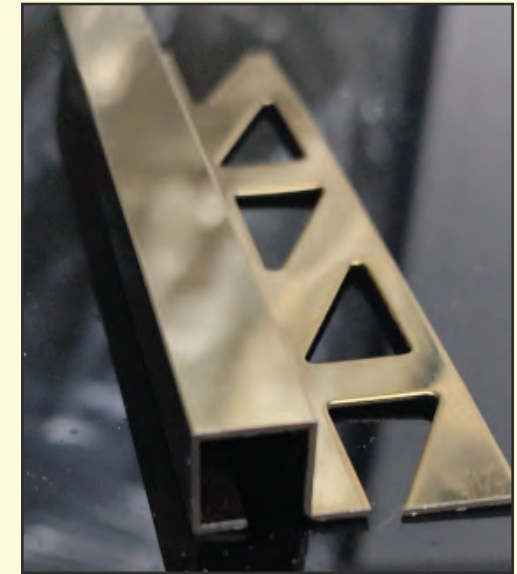

**Available Sizes**

**Length**

H = 10 mm Stainless Steel (SS 304) Grade

2.1 Mtr  
2.5 Mtr  
3 Mtr

**Available Sizes**

**Length**

H = 10 mm Stainless Steel (SS 304 Grade)

2.1 Mtr  
2.5 Mtr  
3 Mtr

**Available Sizes**

**Length**

H = 10 mm (Titanium SS)

2.5 Mtr

**Colours:**

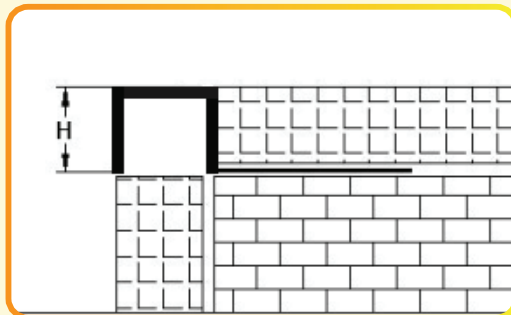

DIMENSIONS



APPLICATION



USAGE

## Cove Trim - PVC



### Available Sizes

H = 7mm

H = 10 mm

### Length

7 Feet

7 Feet

### Available Quantity

10 Nos / Pack and

200 Nos / Box

### Colours:

White

Ivory

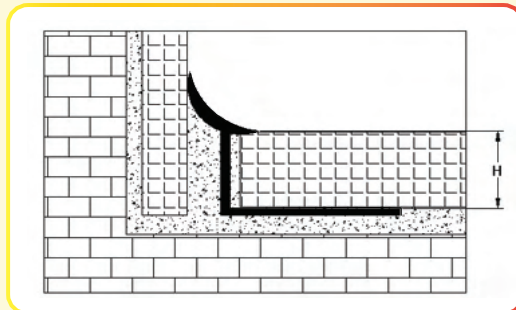

DIMENSIONS



APPLICATION



USAGE



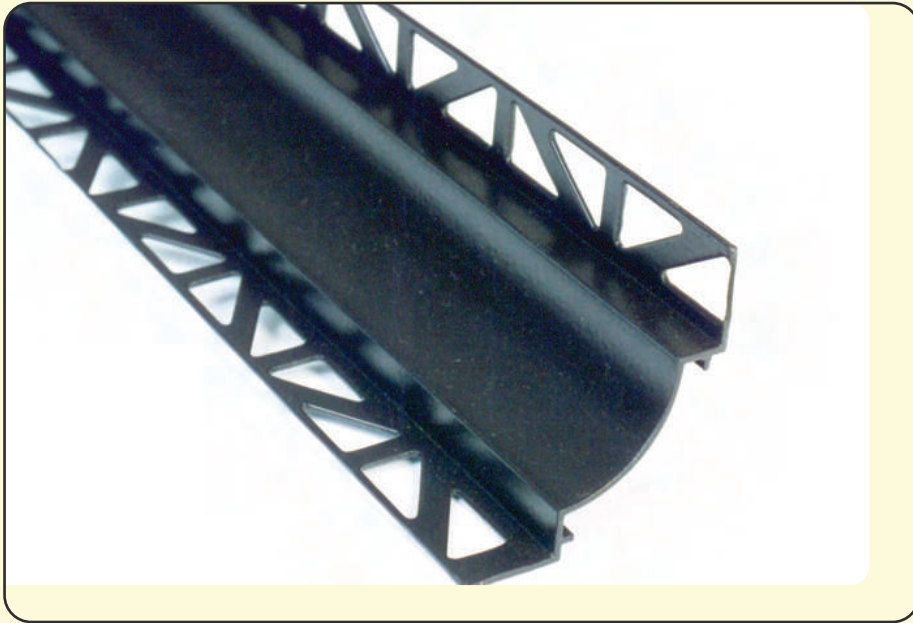

**Available Sizes**

H = 10 mm (Natural / Anodised/Powder coated)

H = 40 mm (Curved Surface Anodised/Powder coated)

**Length**

3 Mtr

3 Mtr

**Colours:**

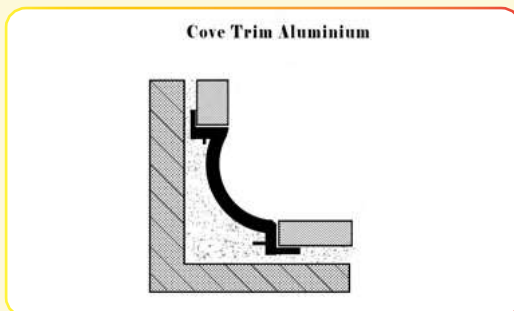

DIMENSIONS



APPLICATION



USAGE

## Step Nosing (Stair case )

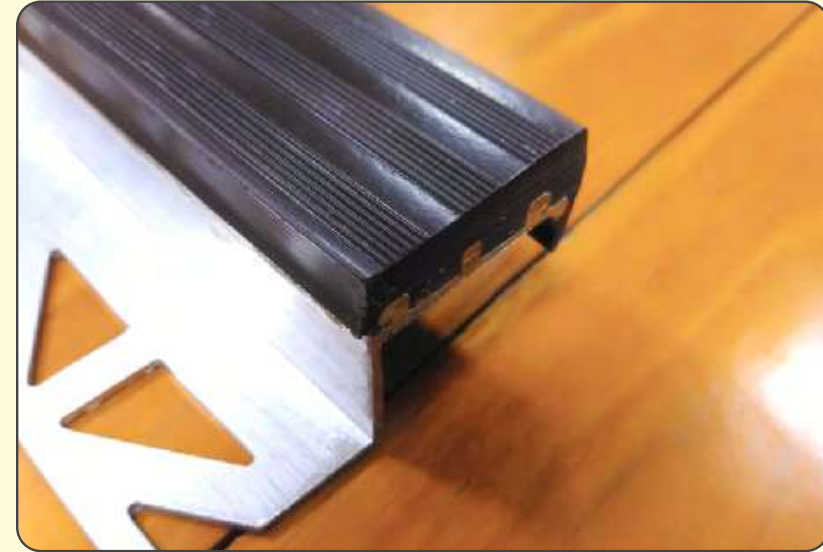

**Aluminium with PVC Insert**

### Available Sizes

H = 7 mm	w= 33 mm
H = 20 mm	w= 33 mm
H = 30 mm	w= 33 mm

### Length

3 Mtr
3 Mtr
3 Mtr

### Colours:

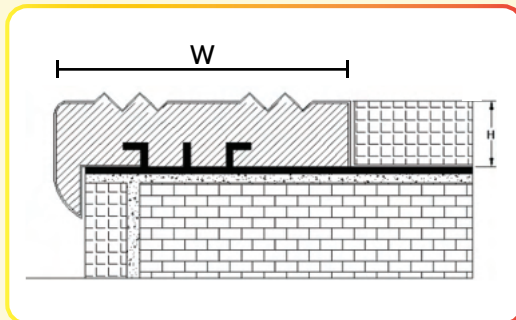

**DIMENSIONS**

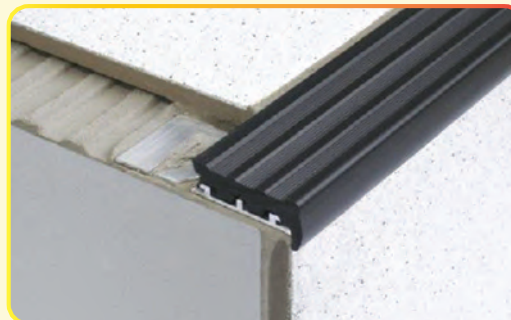

**APPLICATION**



**USAGE**



*Step Nosing (for Existing Floors)*



**Aluminium Base Pvc Insert**



**Only Aluminium**

**Available Sizes**

- W = 38 mm
- W = 60 mm

**Length**

- 3 Mtr
- 3 Mtr

**Colours:**



**Available Sizes**

- W = 50 mm

**Length**

- 3 Mtr

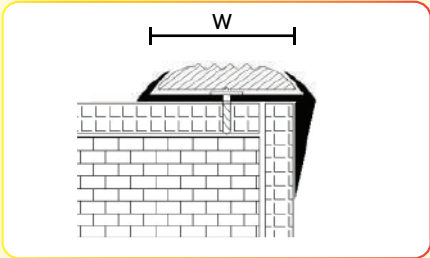

DIMENSIONS



USAGE



USAGE

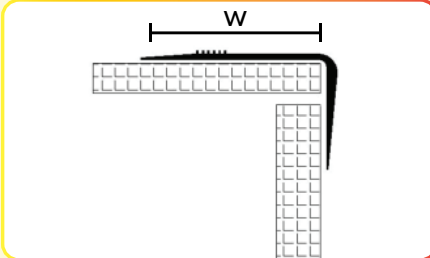

DIMENSIONS

**Step Nosing (for Existing Floors)**



**Only Pvc**



**Only Pvc Double Colour**



**Anti Skid Nosing**

**Available Sizes**

W= 45 mm (Only PVC)

**Length**

3 Mtr



**Available Sizes**

W= 45 mm  
(Only PVC Double colour)

**Length**

3 Mtr

**Available Sizes**

W= 1 inche  
W= 2 inche

**Length**

18 Mtr  
18 Mtr

**Anti Skid Nosing**

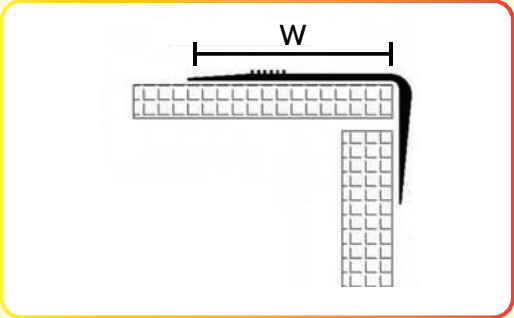

**DIMENSIONS**



**APPLICATION**



**USAGE**

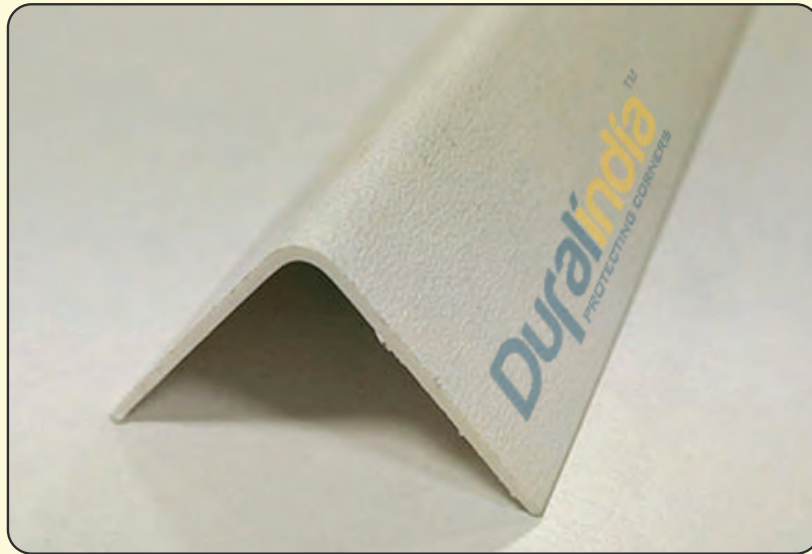

Corner Guard (Pvc Textured Finish)

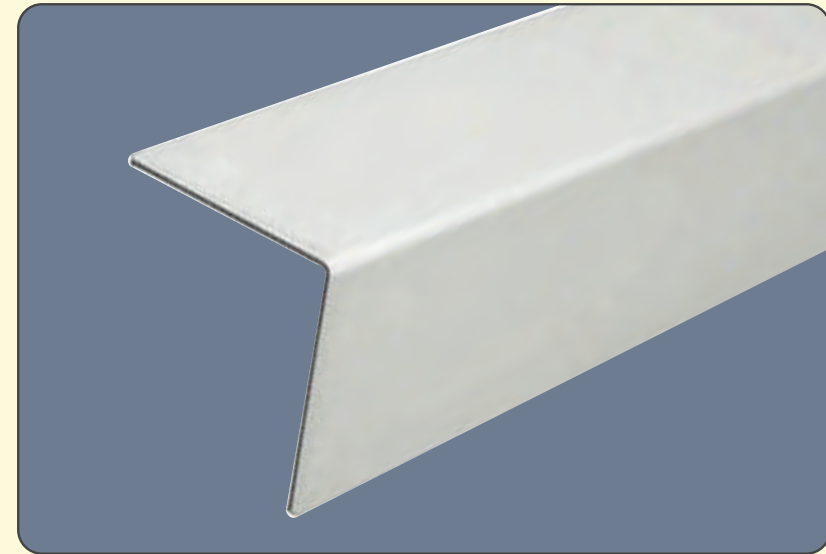

Corner Guard (Pvc Plain)

Available Sizes

W= 25 X 25 mm (Plain)

Length

3 Mtr

Available Sizes

W= 38 X 38 mm (Textured Finish)

Length

3 Mtr

Plain Colours:



Textured Colours:

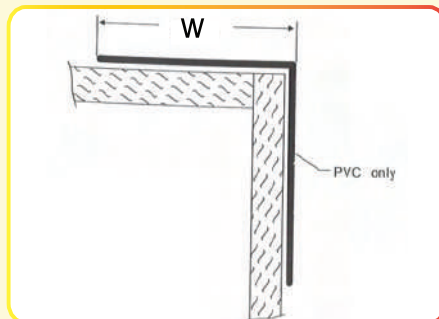

DIMENSIONS

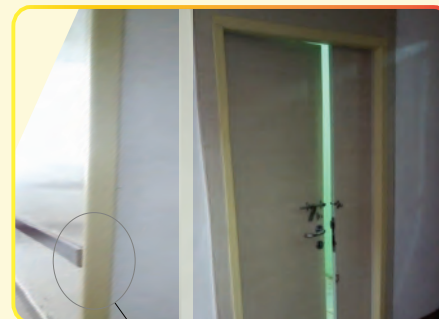

APPLICATION



USAGE



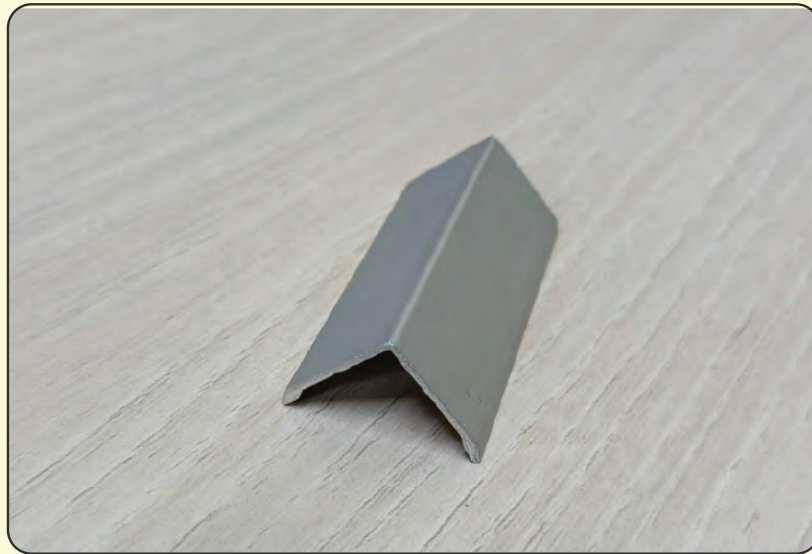

**Corner Guard**

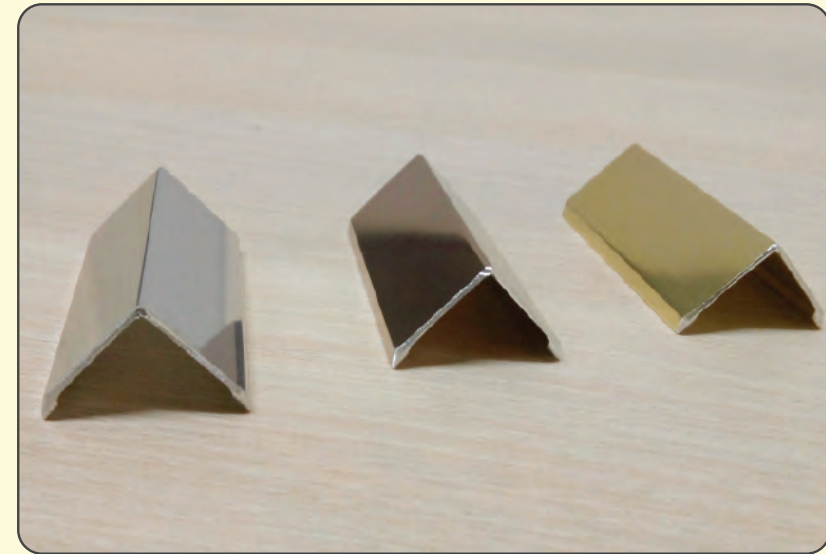

**Corner Guard (Aluminium Anodized)**

**Available Sizes**

12 x 12 mm

19 x 19 mm

25 x 25 mm

**Length**

3 Mtr

3 Mtr

3 Mtr

**Colours:**

**Corner Guard (Rose Gold Anodized)**

**Corner Guard (Gold Anodized)**

**Corner Guard (Silver Anodized)**

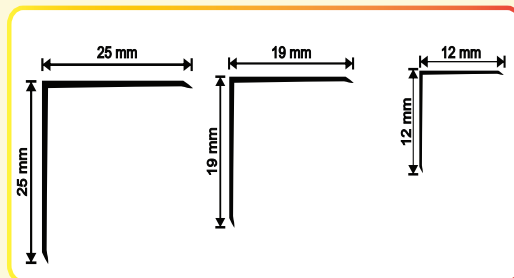

**DIMENSIONS**

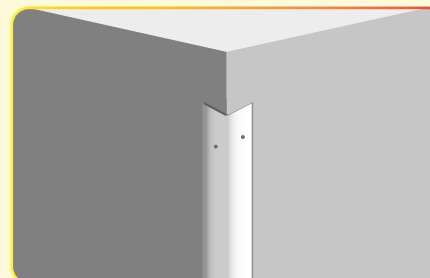

**APPLICATION**



**USAGE**



## Corner Guard Alu with Pvc

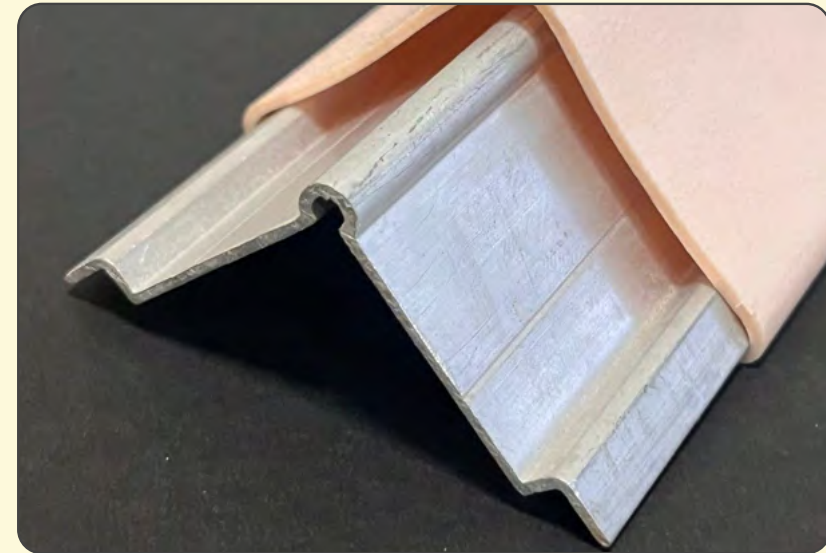

**Aluminium Base with  
Pvc Insert and End cap**

**Available Sizes**  
**(50x50) mm**

**Length**  
**3 Mtr**

**Colours:**

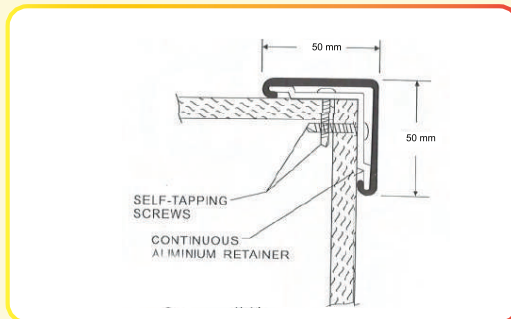

**DIMENSIONS**



**APPLICATION**



**USAGE**

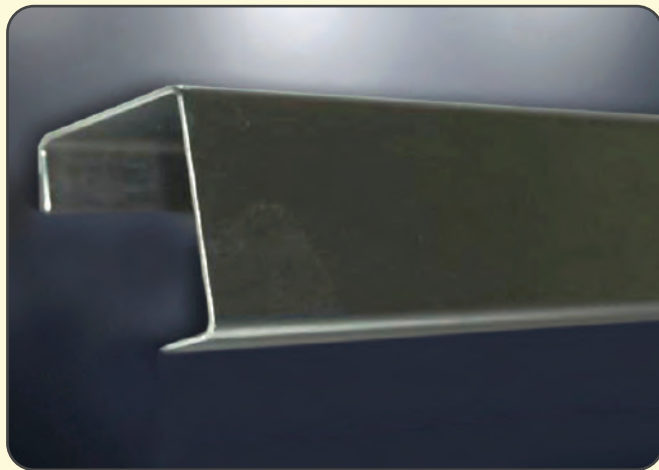

**Guard (Clamp Type)**



**Clamp**



**Modified Corner Guard without Clamp**

**Available Sizes**

25 x 25 mm (with Clamp)

50 x 50 mm (with Clamp)

**Length**

2.5 Mtr

2.5 Mtr

**Available Sizes**

25 x 25 mm (Modified Corner without Clamp)

50 x 50 mm (Modified Corner without Clamp)

**Length**

2.5 Mtr

2.5 Mtr

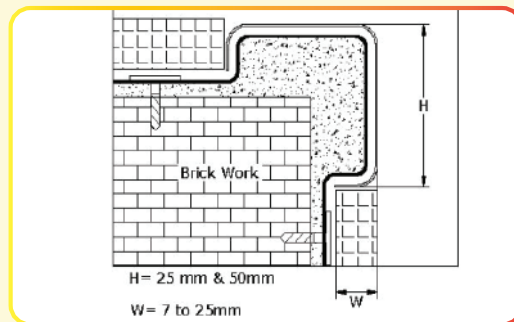

**DIMENSIONS**

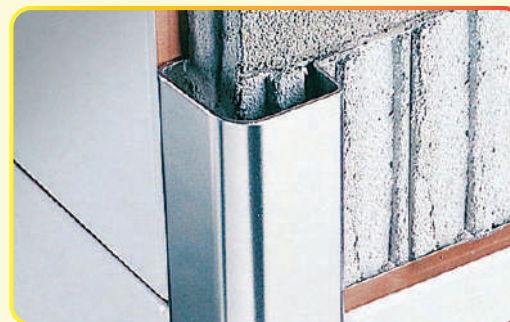

**APPLICATION**

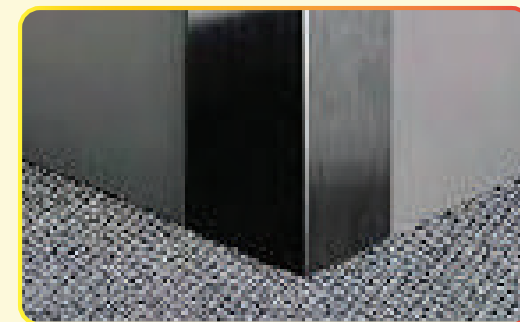

**USAGE**

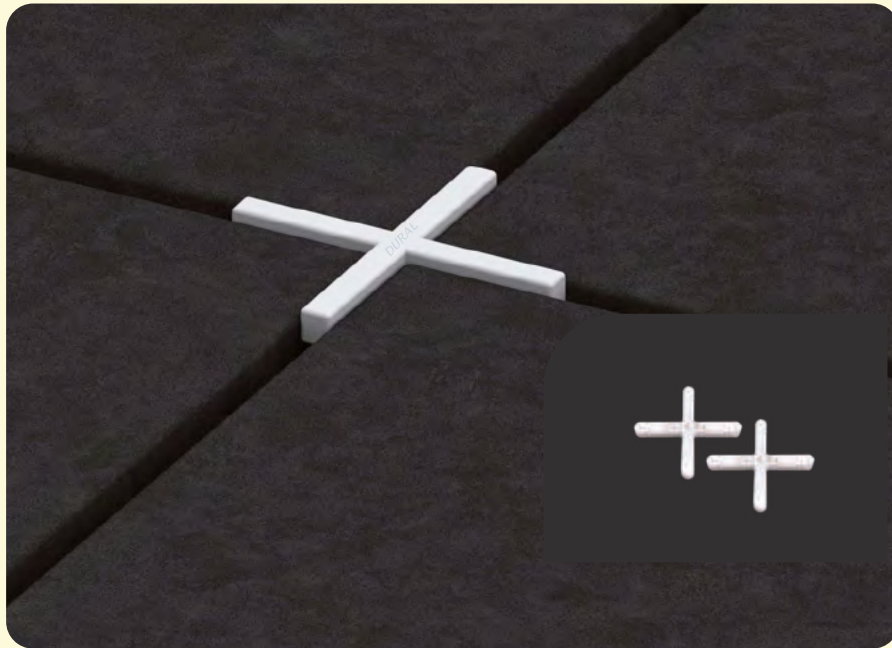

*Size (100 Nos Per Pkt)*

*Size (500 Nos Per Pkt)*

- W = 1.6 mm
- W = 2 mm
- W = 3 mm
- W = 4 mm
- W = 5 mm
- W = 6 mm
- W = 8 mm
- W = 10 mm

- W = 1.6 mm
- W = 2 mm
- W = 3 mm
- W = 4 mm
- W = 5 mm
- W = 6 mm

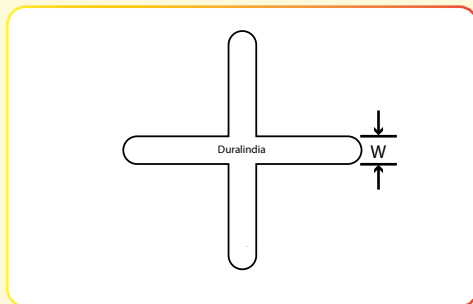

DIMENSIONS



APPLICATION

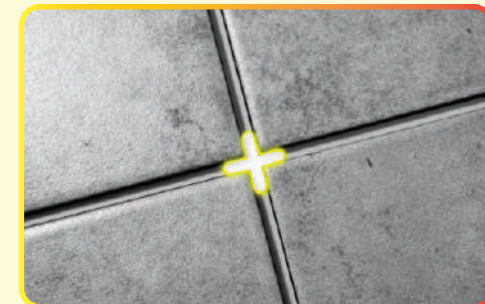

USAGE

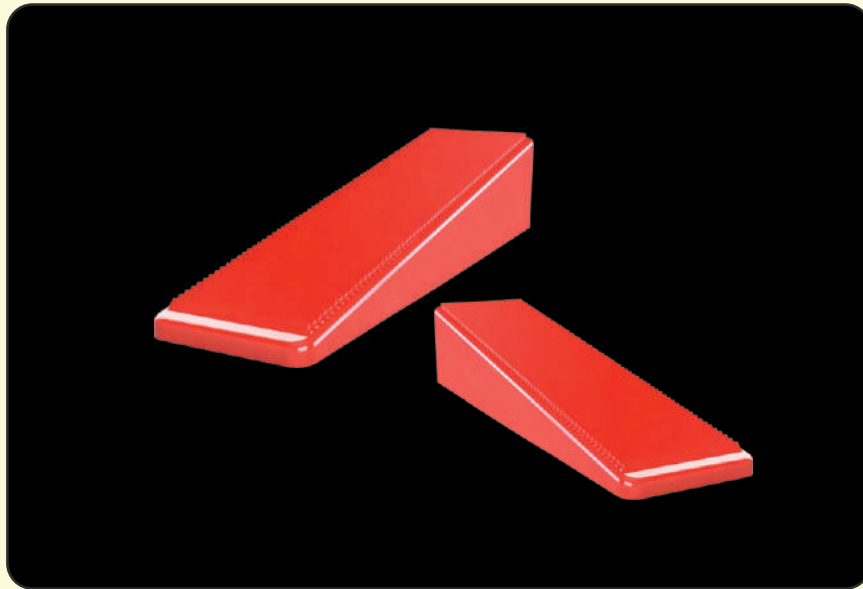

*Wedges*

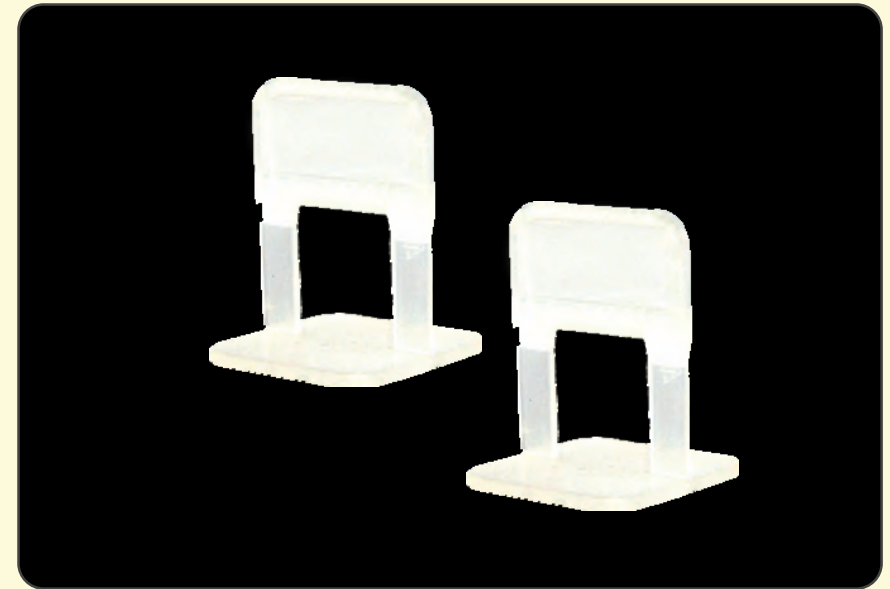

*Clip*

*Available Sizes*

- 1.5 mm
- 2 mm
- 3 mm

*Colours:*

*Wedges*



*Red*



*Yellow*

*Clip*



*Transparent Colour*

*100 Nos Per Packet*

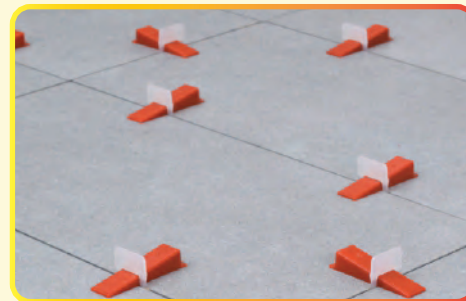

APPLICATION



USAGE



*Parking Guard*

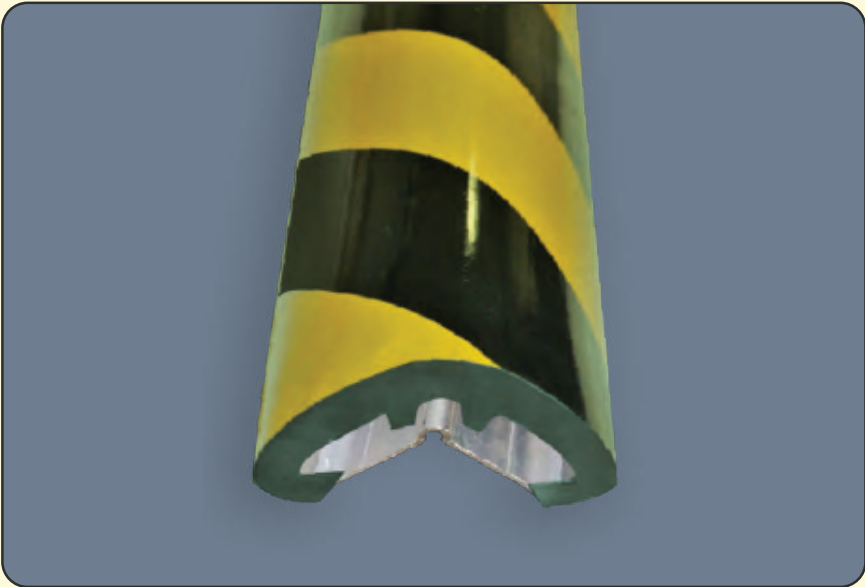

*Parking Guard (Aluminium with Rubber)*



*Parking Guard (Rubber)*

**Available Sizes**  
50 X 50 mm

**Length**  
1 Mtr

**Available Sizes**  
100 x 100 mm

**Length**  
800 mm

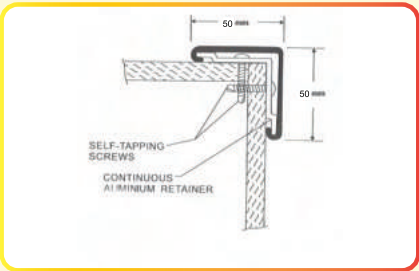

DIMENSIONS



USAGE

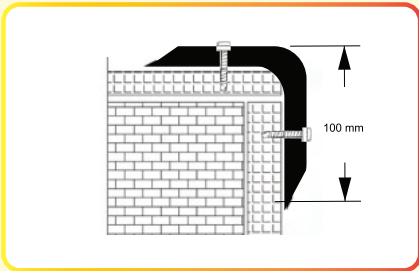

DIMENSIONS



USAGE

**Wall Guard**



**Wall Guard(Aluminium Base with pvc insert )**

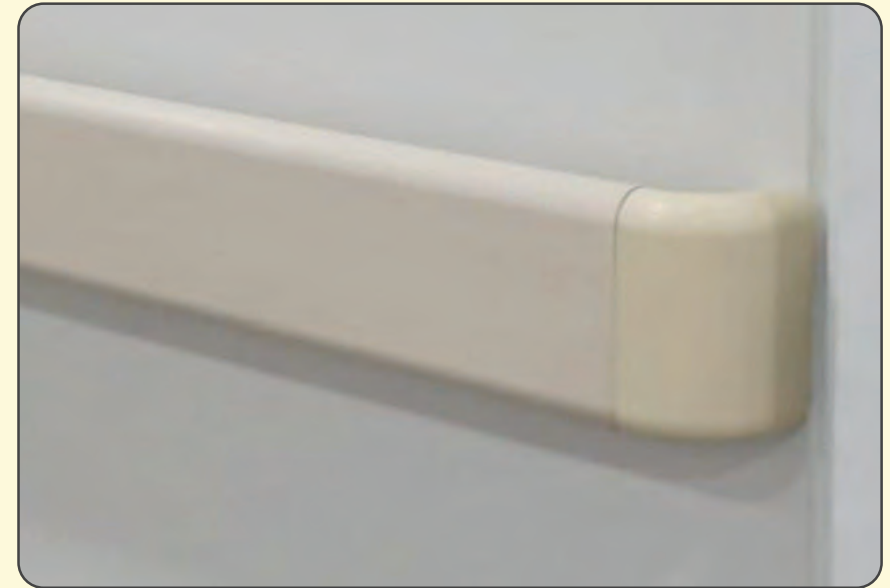

**Handrail Wall Guard**

**Available Sizes**

100 mm  
155 mm

**Length**

2.5 Mtr  
2.5 Mtr

**Available Sizes**

155 mm

**Length**

2.5 Mtr



**DIMENSIONS**



**END CAP**

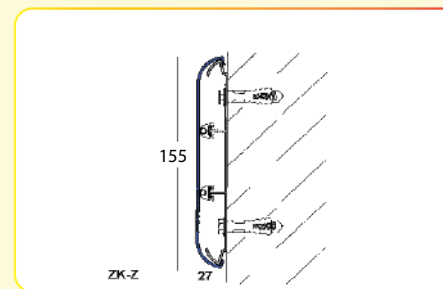

**DIMENSIONS**

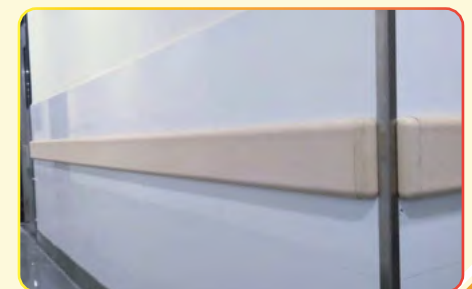

**USAGE**

## Skirting Profile

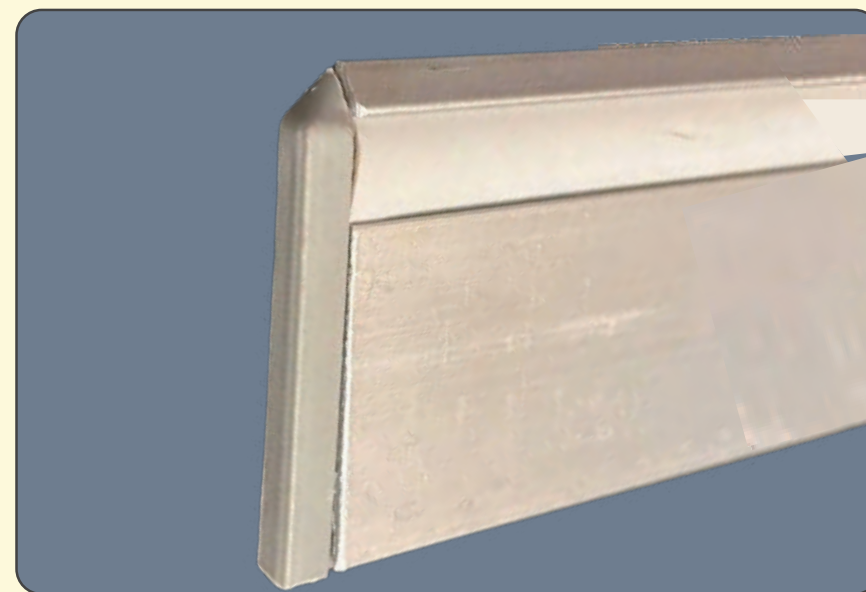

### Available Sizes

H= 50 mm

H= 75 mm

H= 100 mm

### Length

3 Mtr

3 Mtr

3 Mtr

### Colours:

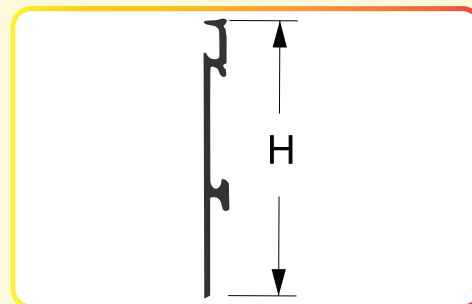

DIMENSIONS

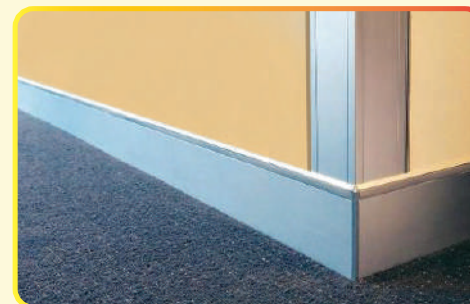

USAGE

## Skirting Toe Profile

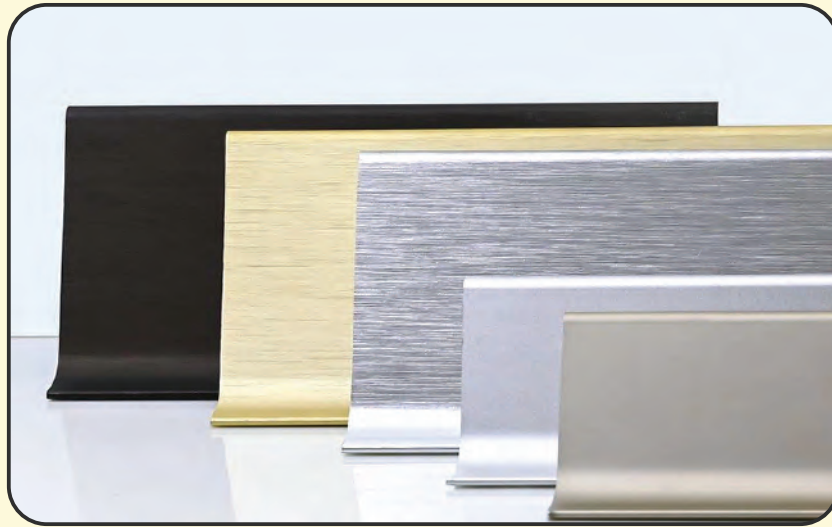

### Available Sizes

H = 60 mm

H = 80 mm

H = 100 mm

### Length

3 Mtr

3 Mtr

3 Mtr

### Colours:

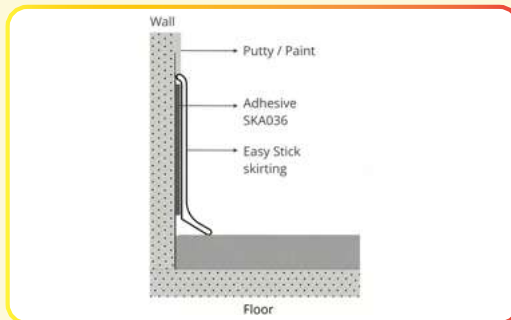

DIMENSIONS



APPLICATION



USAGE



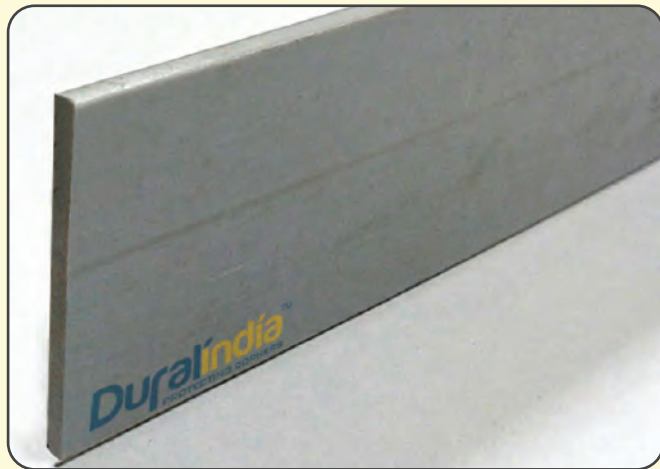

**Floor Divider PVC**



**Floor Divider Aluminium**



**Floor Divider Aluminium (Curved Line)**

**Available Sizes**

W = 3 x 25 mm

W = 4 x 30 mm

**Length**

3 Mtr

3 Mtr

**Available Sizes**

W = 10 x 25 mm

**Length**

3 Mtr

**Available Sizes**

W = 8 x 22 mm

**Length**

3 Mtr

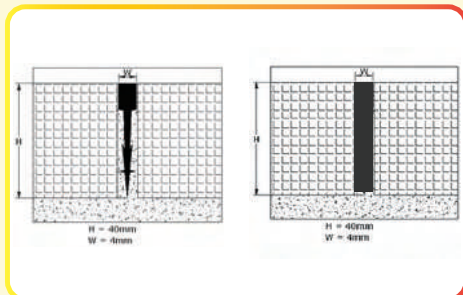

**DIMENSIONS**



**APPLICATION**

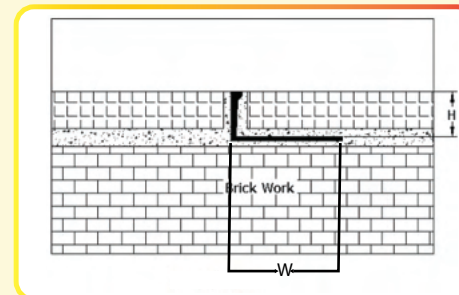

**DIMENSIONS**



**USAGE**

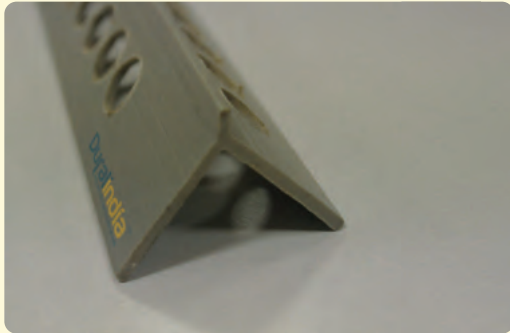

**Corner Bead**

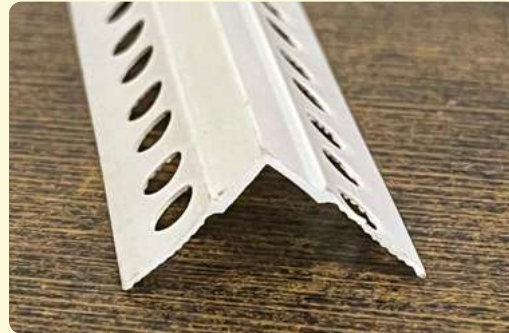

**Plaster Bead PVC**

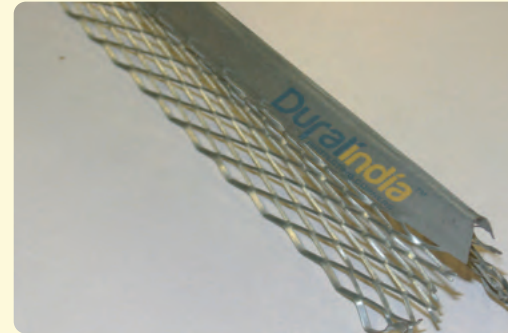

**GI Corner Bead**

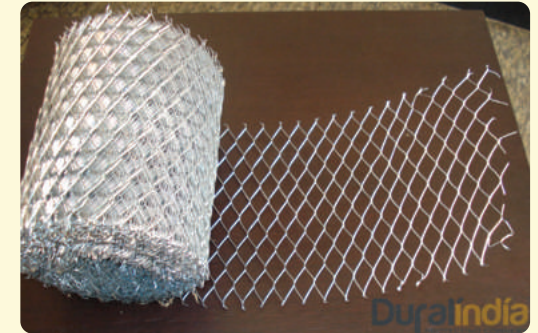

**Plaster Mesh**

**Available Sizes**

H = 5 mm

**Length**

7 feet

**Available Sizes**

H = 23 x 23 mm

**Length**

7 feet

**Available Sizes**

H = 45 x 45 x 0.45 mm 2.44 Mtr

**Length**

**Available Sizes**

H = 4 inch

H = 6 inch

H = 8 inch

**Length**

15 Mtr

15 Mtr

15 Mtr

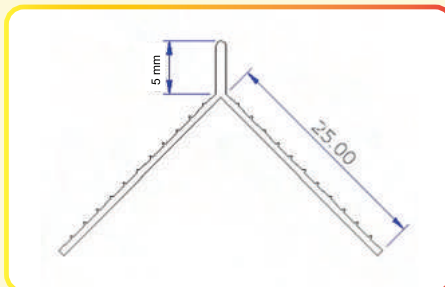

**DIMENSIONS**

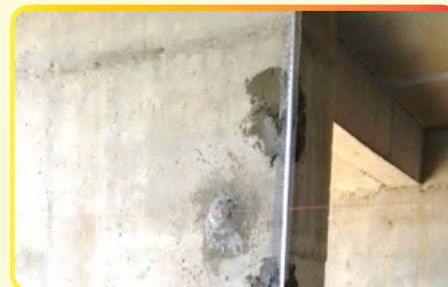

**APPLICATION GI**



**APPLICATION  
(PLASTER MESH)**



**APPLICATION PVC**



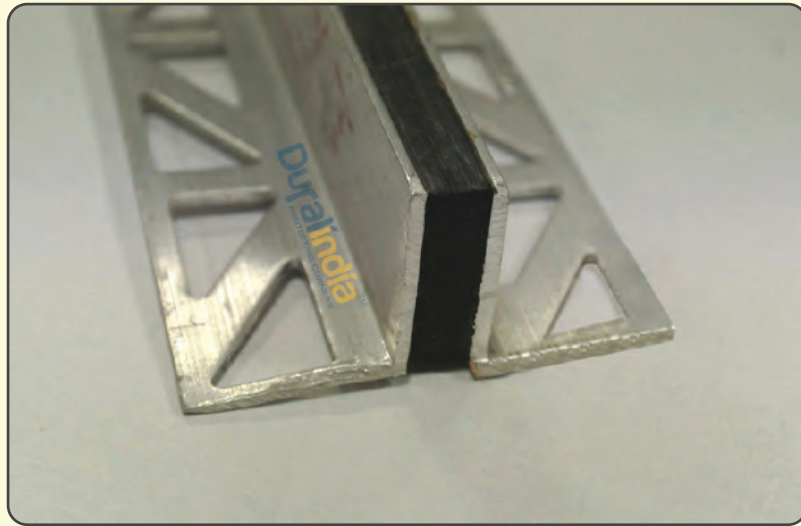

*Floor to Floor*

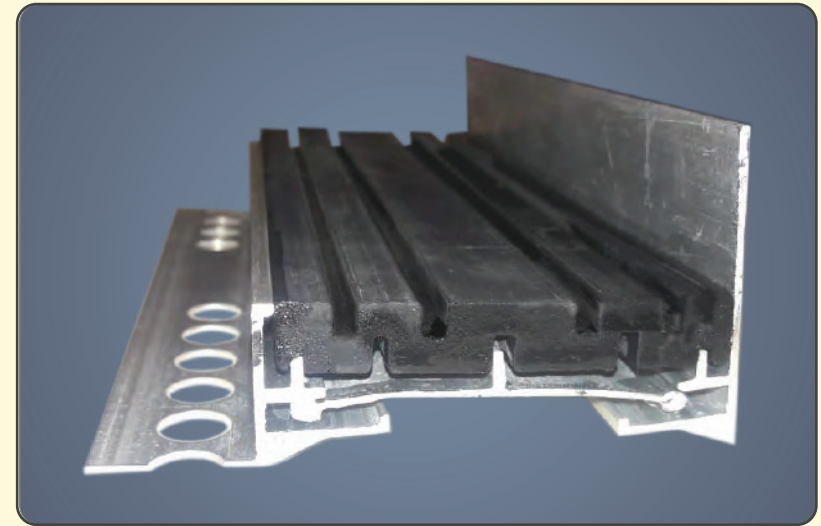

*Floor to Wall*

**Available Sizes**

W x H  
25 x 25 mm  
50 x 25 mm  
75 x 25 mm

**Length**

3 Mtr  
3 Mtr  
3 Mtr

**Colours:**



**Available Sizes**

W x H  
25 x 25 mm  
25 x 50 mm

**Length**

7 feet  
7 feet

**Colours:**

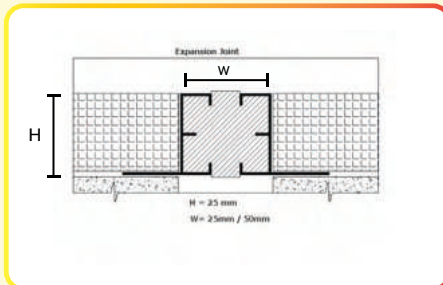

**DIMENSIONS**



**APPLICATION**  
FLOOR TO FLOOR

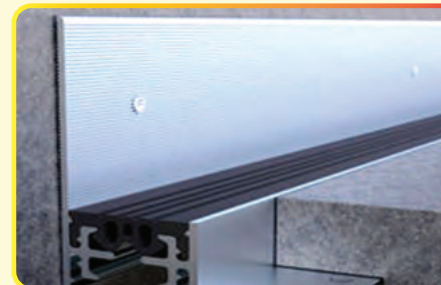

**APPLICATION**  
FLOOR TO WALL



**USAGE**  
EXPANSION JOINT



*Expansion Joint Cover*

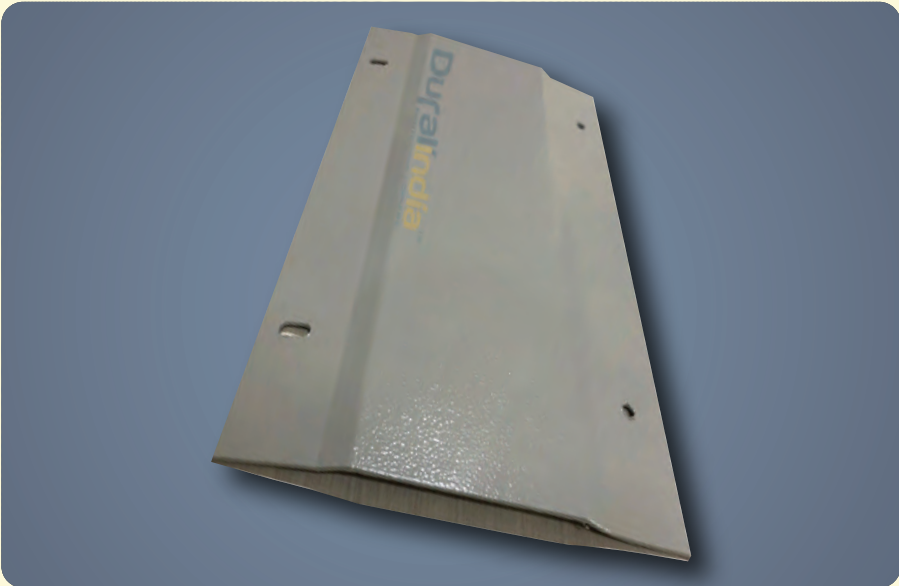

*Expansion Joint Cover (Powder coated)*

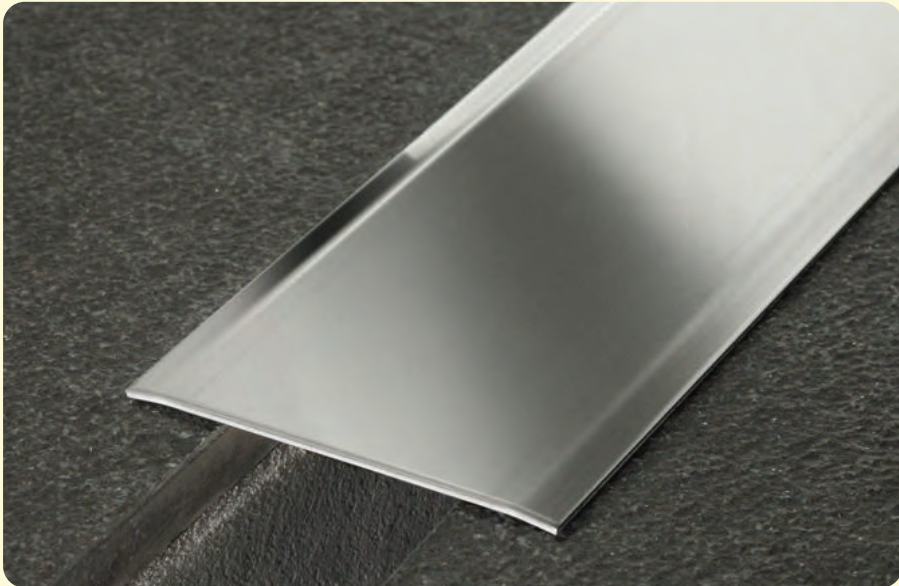

*Expansion Joint Cover*

*Available Sizes*

- w = 110 mm
- w = 150 mm
- w = 300 mm

*Length*

- 3 Mtr
- 3 Mtr
- 2.5 Mtr

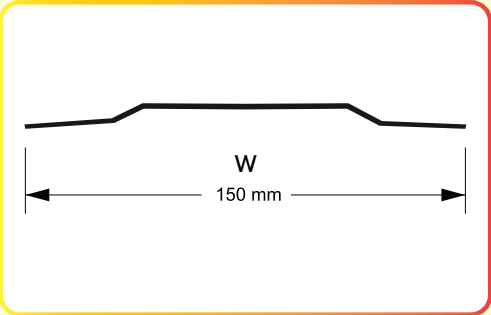

DIMENSIONS



APPLICATION  
FLOOR TO FLOOR



APPLICATION  
FLOOR TO FLOOR

## Control Joint

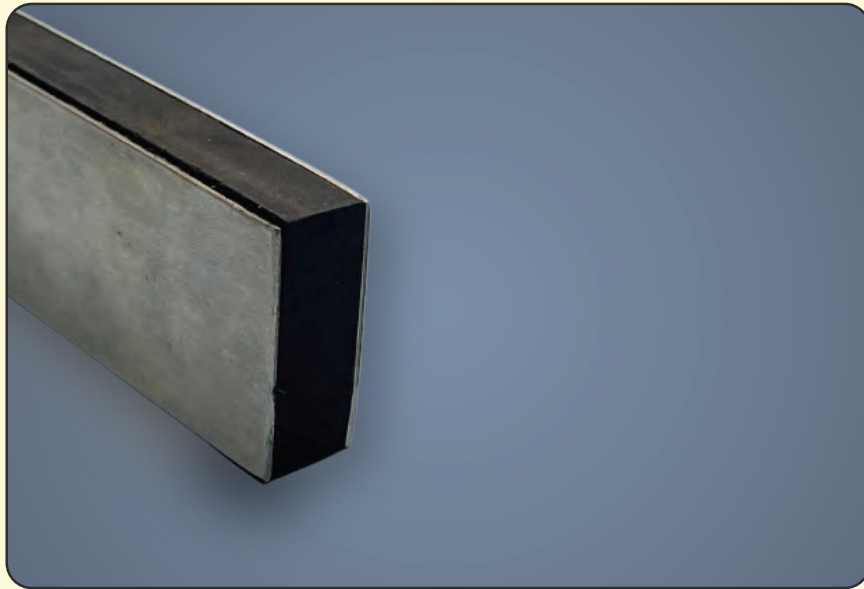

**Control Joint (I - Type)**

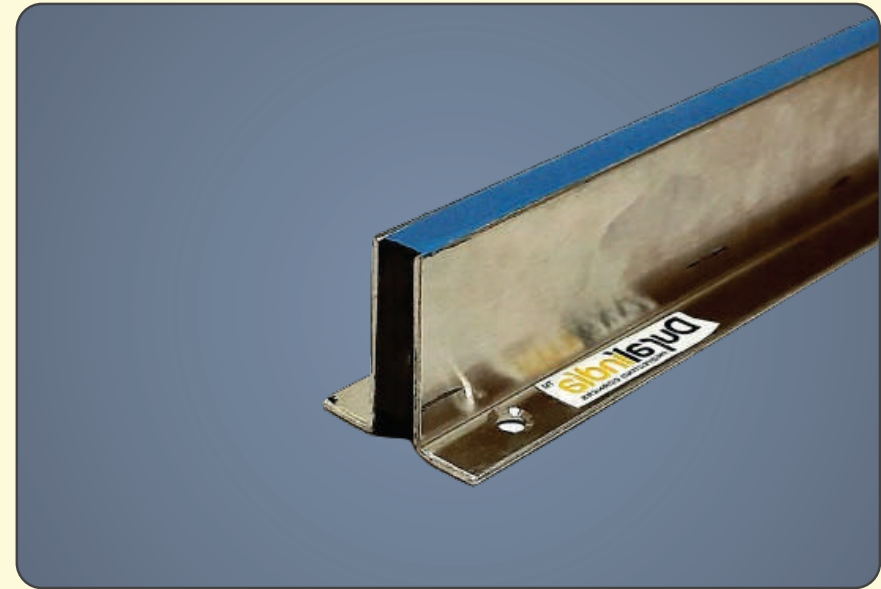

**Control Joint (T- Type)**

### Available Sizes

W x H

10 X 20 mm (Aluminium & Stainless steel)

10 X 30 mm (Aluminium & Stainless steel)

14 X 30 mm (Aluminium & Stainless steel)

### Length

3 Mtr

3 Mtr

3 Mtr

### Available Sizes

W x H

10 X 25 mm (Aluminium & Stainless steel)

10 X 35 mm (Aluminium & Stainless steel)

10 X 45 mm (Aluminium & Stainless steel)

### Length

3 Mtr

3 Mtr

3 Mtr

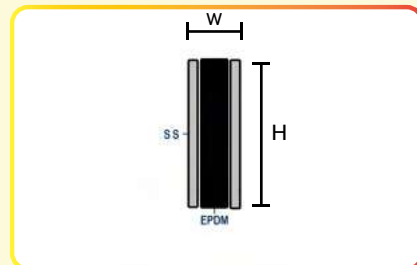

DIMENSIONS



USAGE

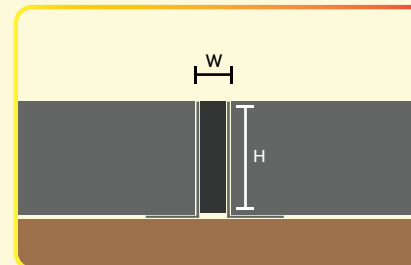

DIMENSIONS



USAGE



Adhesive Grade 100 (20 Kg Per Bag)

Adhesive Grade 200 (20 Kg Per Bag)

Adhesive Grade 300 (20 Kg Per Bag)

Adhesive Grade 400 (20 Kg Per Bag)

Adhesive Grade 1000 (20 Kg Per Bag)



APPLICATION



USAGE





20 Kg Per Box (White, Ivory)

20 Kg Per Box Colours

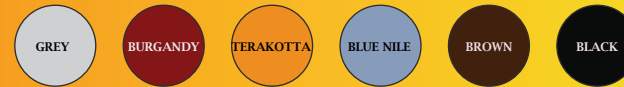

Epoxy Grout (White, Ivory)



APPLICATION

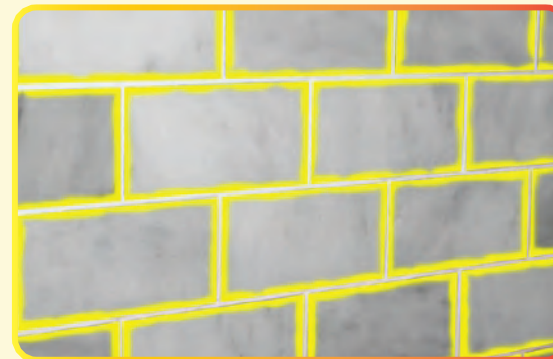

USAGE



*Speed Breaker (PVC)*



*Speed Breaker (Rubber)*



*Car Stopper*

*Available Sizes*

250(L) x 350(W) x 50 (H) mm    0.5 Mtr  
 500(L) x 400(W) x 50 (H) mm    0.5 Mtr  
 500(L) x 400(W) x 75 (H) mm    0.5 Mtr  
 250(L) x 750(W) x 75 (H) mm    0.5 Mtr

*Length*

*Available Sizes*

500(L) x 350(W) x 50(H) mm  
 (Speed breaker Rubber)

*Available Sizes*

600(L) x 125(W) x 100 (H) mm  
 500(L) x 160(W) x 125 (H) mm



**USAGE**



**APPLICATION**



**APPLICATION**



*Trans Profile*

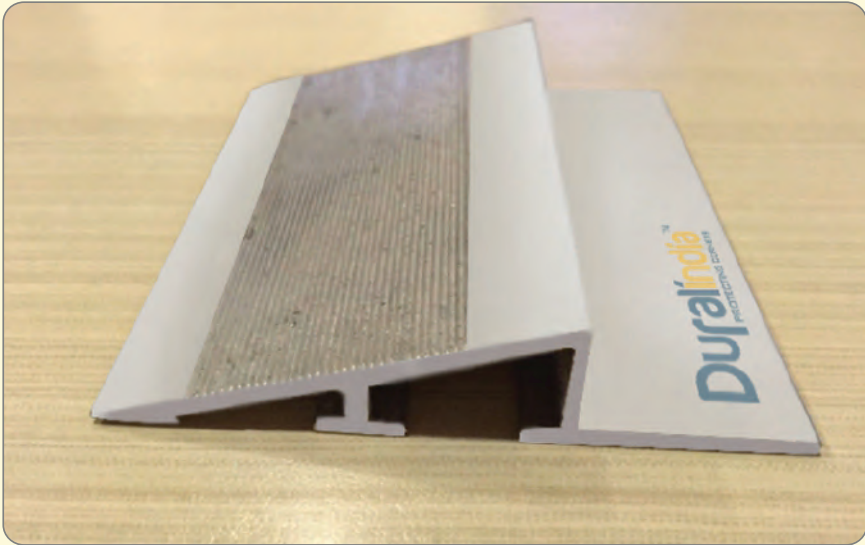

*Trans Profile*

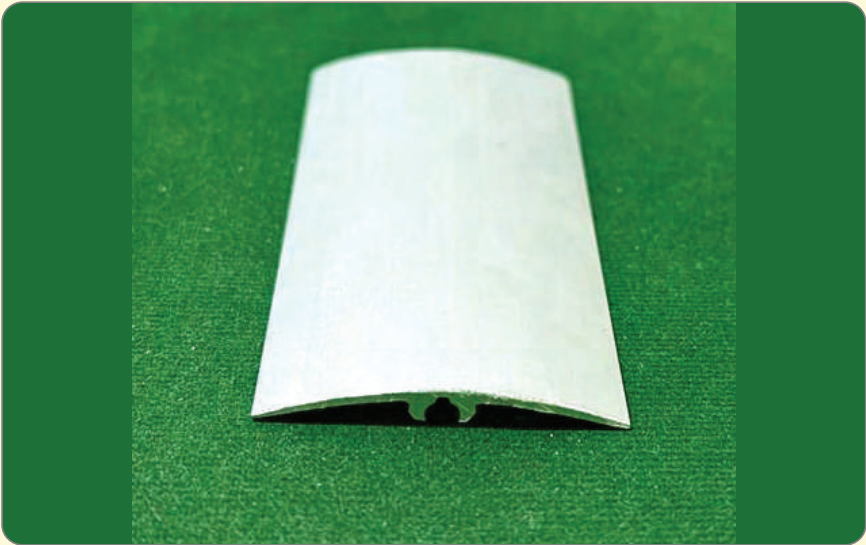

*Trans Profile Floor Cover*

*Available Sizes*

H = 12 mm

*Length*

3 Mtr

*Available Sizes*

W = 30 mm

W = 40 mm

*Length*

3 Mtr

3 Mtr

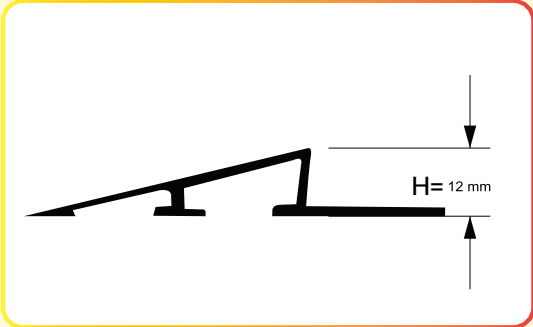

**DIMENSIONS**



**USAGE**



## T - Section Profile

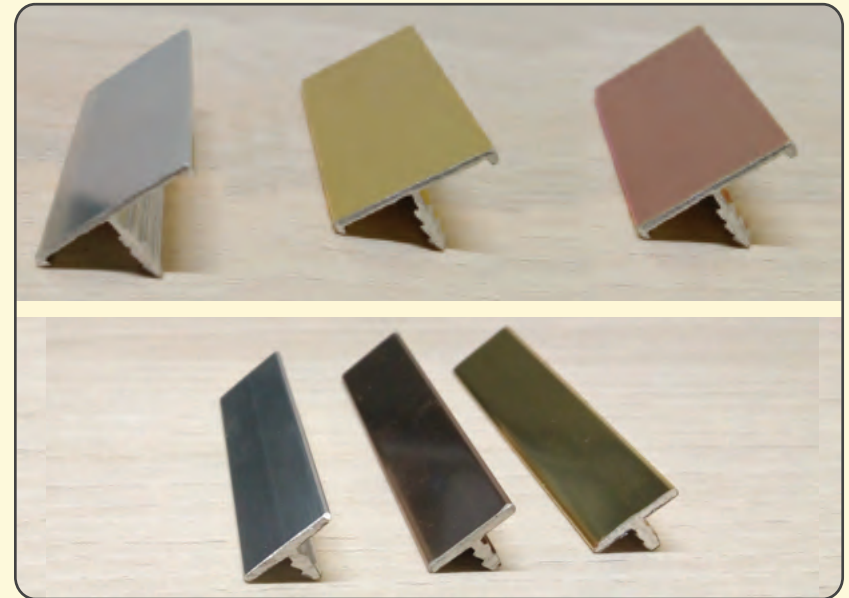
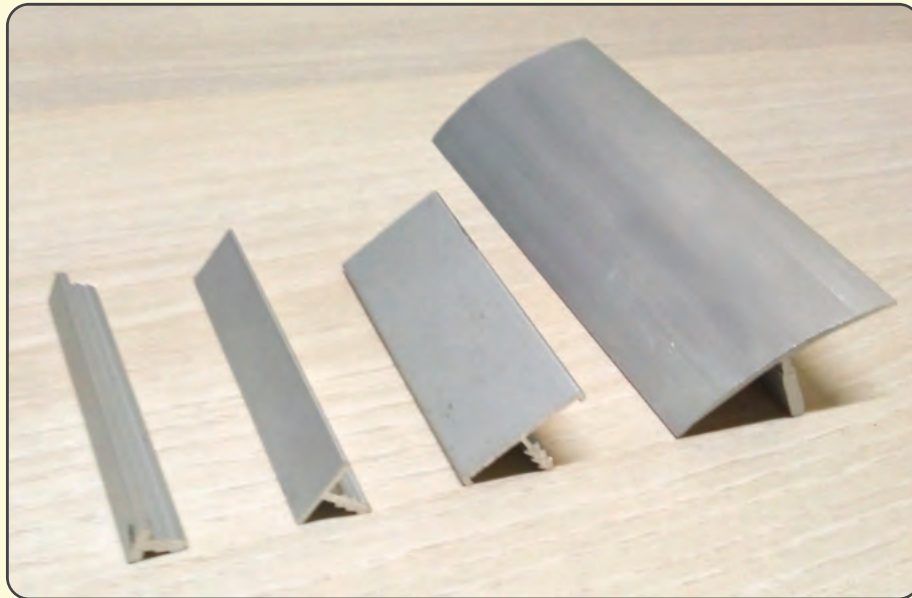

### Available Sizes

7 mm  
12 mm  
23 mm  
40 mm

### Length

3 Mtr  
3 Mtr  
3 Mtr  
3 Mtr

### Colours:

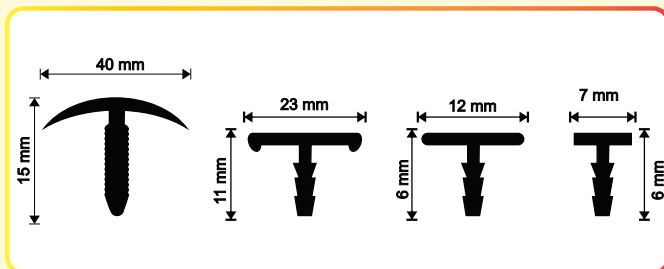

DIMENSIONS

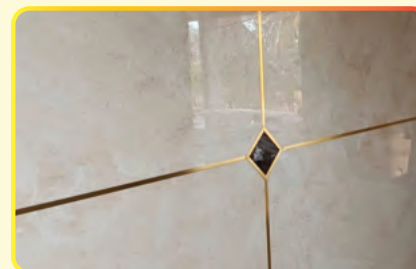

APPLICATION



USAGE

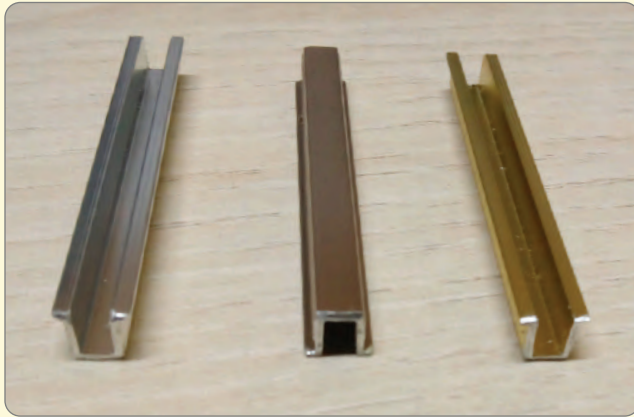

Groove Profile

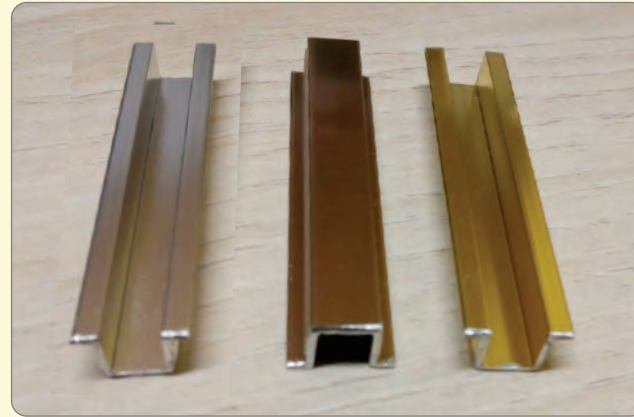

Multipurpose Trim

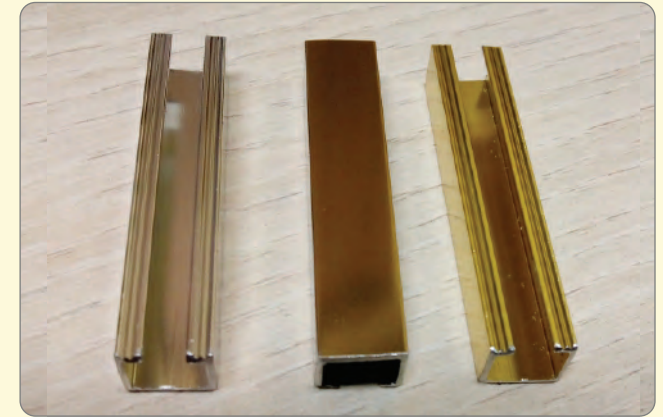

Multipurpose Groove Profile

Available Sizes

H = 5 x 6.7 mm

H = 10 x 8 mm

H = 15 x 7 mm

Length

3 Mtr

3 Mtr

3 Mtr

Available Sizes

H = 5 x 6.7 mm

H = 10 x 7 mm

Colours:



Length

3 Mtr

3 Mtr

Available Sizes

H = 10 x 8 mm  
(Multipurpose)

Colours:



Length

3 Mtr

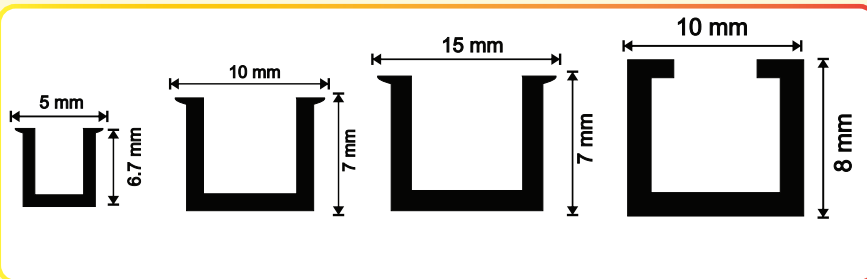

DIMENSIONS

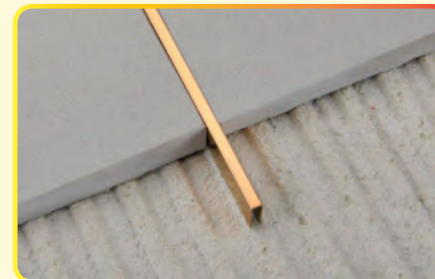

APPLICATION



USAGE



*Backer Rod*

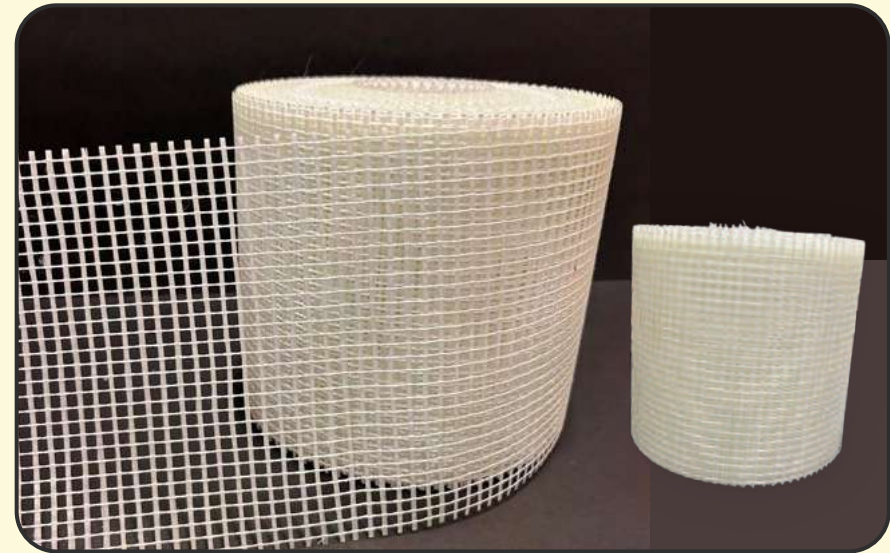

*Fiberglass mesh*

*Available Sizes*

- 25 mm
- 30 mm
- 50 mm
- 75 mm
- 80 mm

*Length*

- 3 Mtr
- 3 Mtr
- 3 Mtr
- 3 Mtr
- 3 Mtr

*Available Sizes*

6 Inch

*Length*

50 Mtr



USAGE

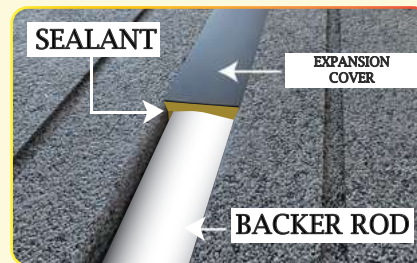

USAGE



APPLICATION  
(Fiberglass Mesh)



*Tile Levelling machine / F - Profile*

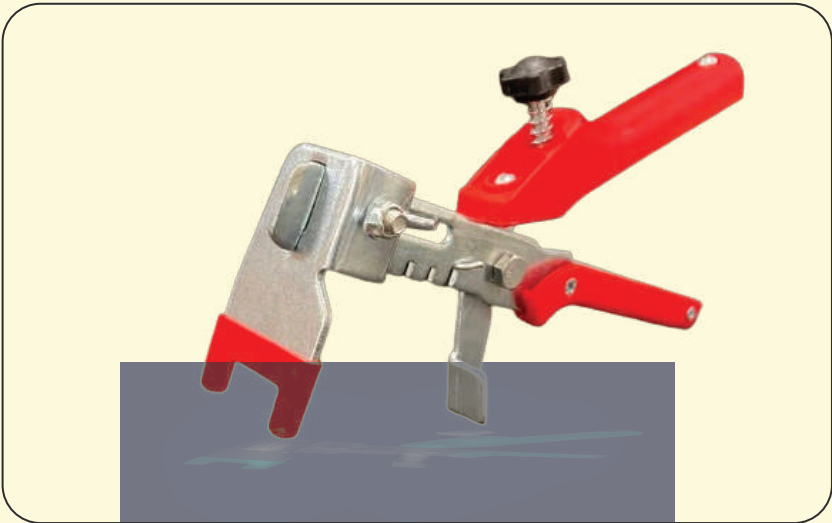

*Tile levelling machine*

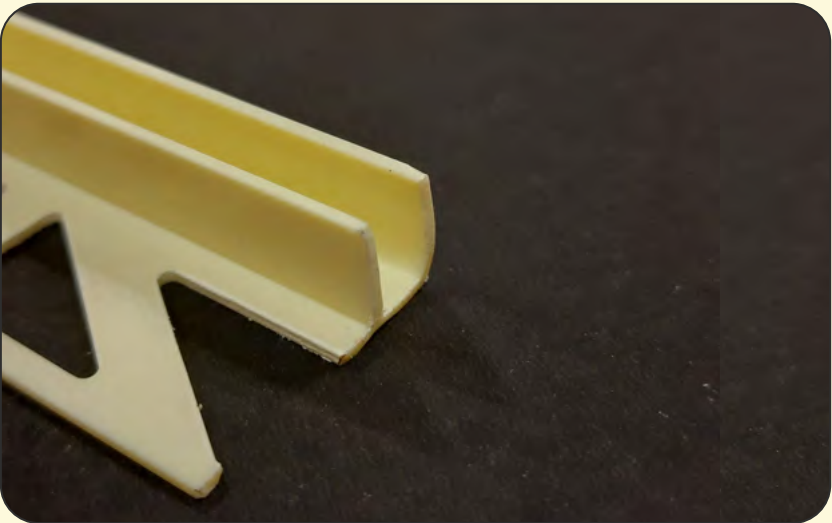

*F - Profile PVC*



**USAGE**

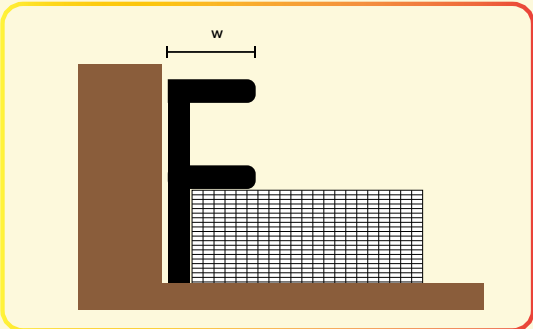

**USAGE**



**Available Sizes**

75 X 50 mm (3"x2")

100 X 62 mm (4"x2.1/2")

**Length**

5,6,7,8,10 feet

6,7,8,10 feet

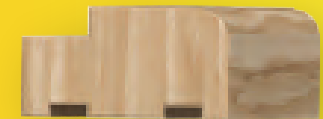

APPLICATION



USAGE

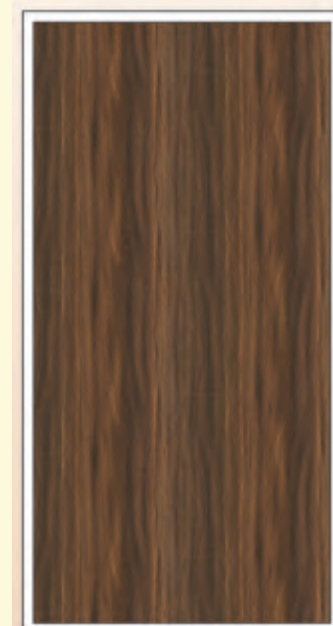

**Available Sizes**

27 mm

30 mm

**Length**

H W

(6.75 x 2.25) Feet

(6.75 x 2.75) Feet

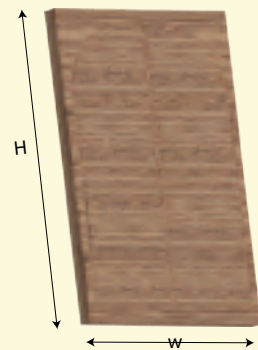

DIMENSIONS



USAGE





## Certificate of Registration

This is to certify that

### Dural Trims and Profiles (P) Ltd

No.40, Industrial Estate, Perungudi, Chennai - 600096, Tamilnadu, India.

has been assessed and registered by BAS Certification as conforming to the requirements of:

### ISO 9001:2015

The Quality Management System is applicable to:

**Manufacturers of Trims and Profiles.**

Certificate number : 1905682  
Initial certification date : 14<sup>th</sup> August 2024  
Certificate valid till : 13<sup>th</sup> August 2027  
1st Surveillance due before : 13<sup>th</sup> August 2025  
2nd Surveillance due before : 13<sup>th</sup> August 2026

For the issuing office  
BAS Certification

Authorized Representative  
Accredited by Accred Services International Board (Europe)  
Kemp House, 160 City Road, London, United Kingdom

To Check certification status: <http://www.asib.co.uk>

Lack of fulfillment of conditions as set out in the certification agreement  
may render this certificate invalid.  
This certificate remains the property of Business Assessment Services

Issuing Office: BAS Certification, Chennai, Tamilnadu, India.



CERTIFICATE - CERTIFICAT - CERTIFICATO - CERTIFICAT - CERTIFICAT

BUSINESS ASSESSMENT SERVICES

# Duralíndia™

PROTECTING CORNERS

*Dural Trims & Profiles Private Limited present in Industry for the past 28 years, this existence has also given way to develop dozens of technicians who own 20+ years of experience in manufacturing profiles. We select high grade of PVC, aluminium, stainless steel, polypropylene and other materials to produce a variety of beautiful, upscale, unique decorative trims and profiles.*

August 2024

## CONTACT US

No.40, Industrial Estate, Perungudi, Chennai – 600 096.

Ph: +91 44 43457373 | [enquiry@duralindia.com](mailto:enquiry@duralindia.com) | +91 98416 57532 | +91 9841091876 | [www.duralindia.com](http://www.duralindia.com)

## FACTORY ADDRESS

### (UNIT 1)

75/76, Mettupalayam Road, Panruti Village, Sriperumbudur Taluk, Kanchipuram District – 631604.  
Tamilnadu, India.

### (UNIT 2)

C 13 and C 14 , SIPCOT industrial complex, Phase II, Cheyyar , Mathur village, Vembakkam Taluk  
Thiruvannamalai dist , Tamilnadu 631701